

LIBRA Partner Institution Universität zu Köln: Symmetries, Lifetimes and the Synthesis of Nuclei



Andreas Zilges
Institut für Kernphysik
Universität zu Köln

Universität zu Köln

Founded in 1388



41.000 students



Annual budget 380 M€



Universität zu Köln

> 300 international cooperations

Albert's International Assistance

about 5000 foreign students



Department of Physics

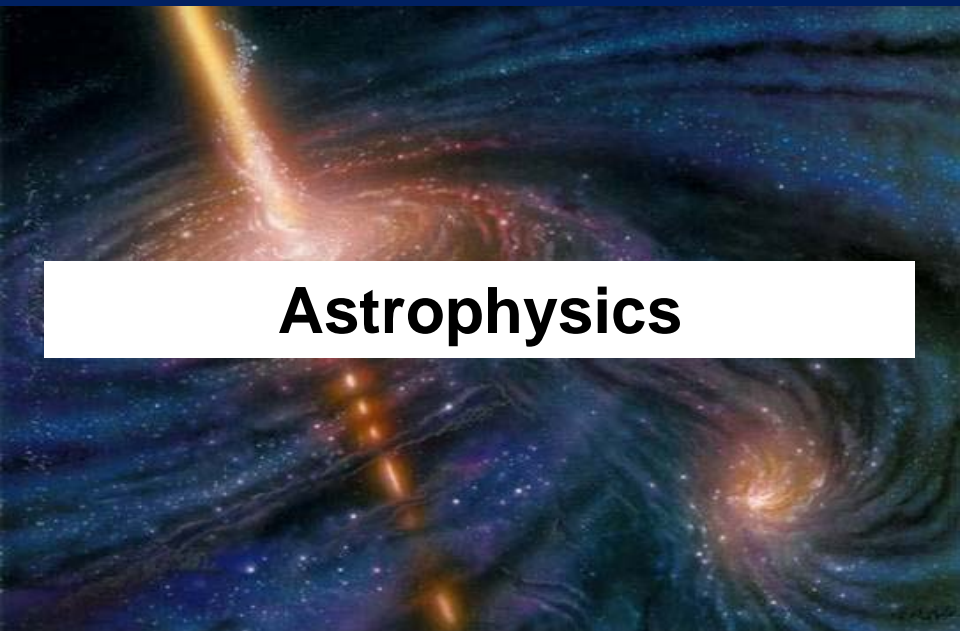

Astrophysics

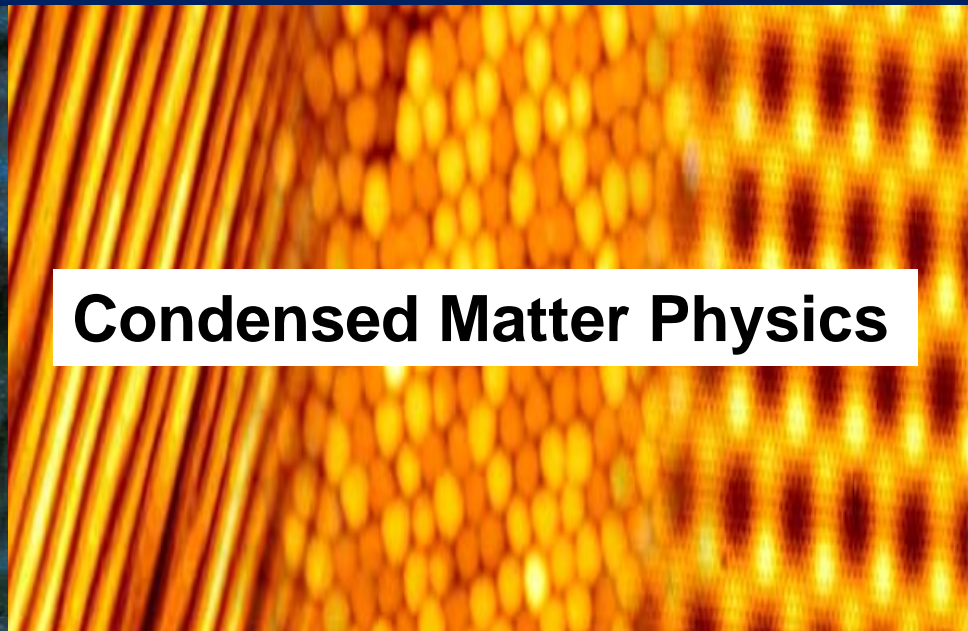

Condensed Matter Physics

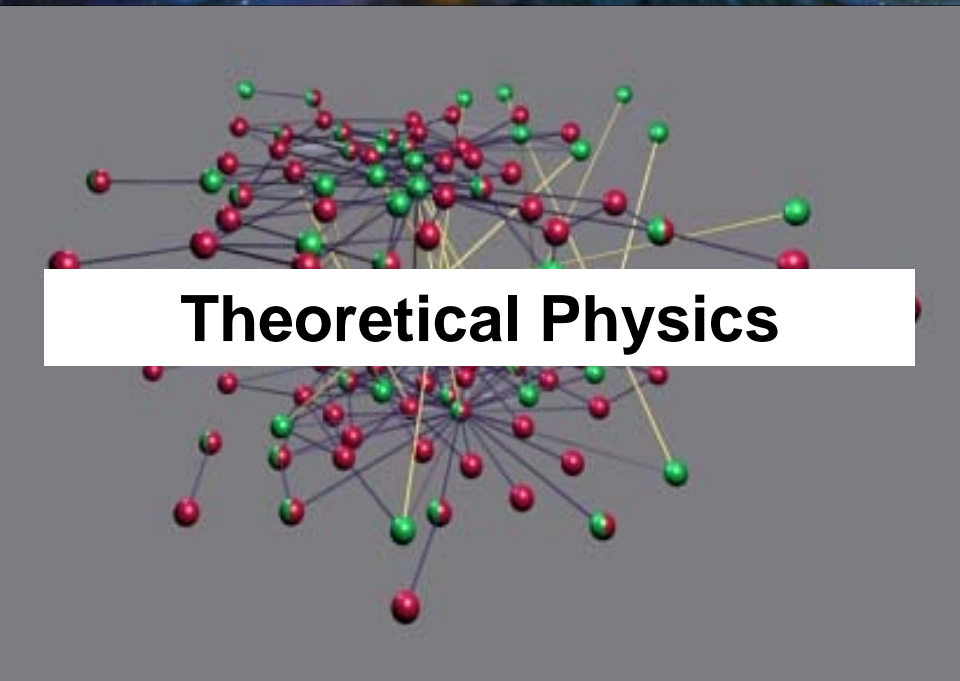

Theoretical Physics

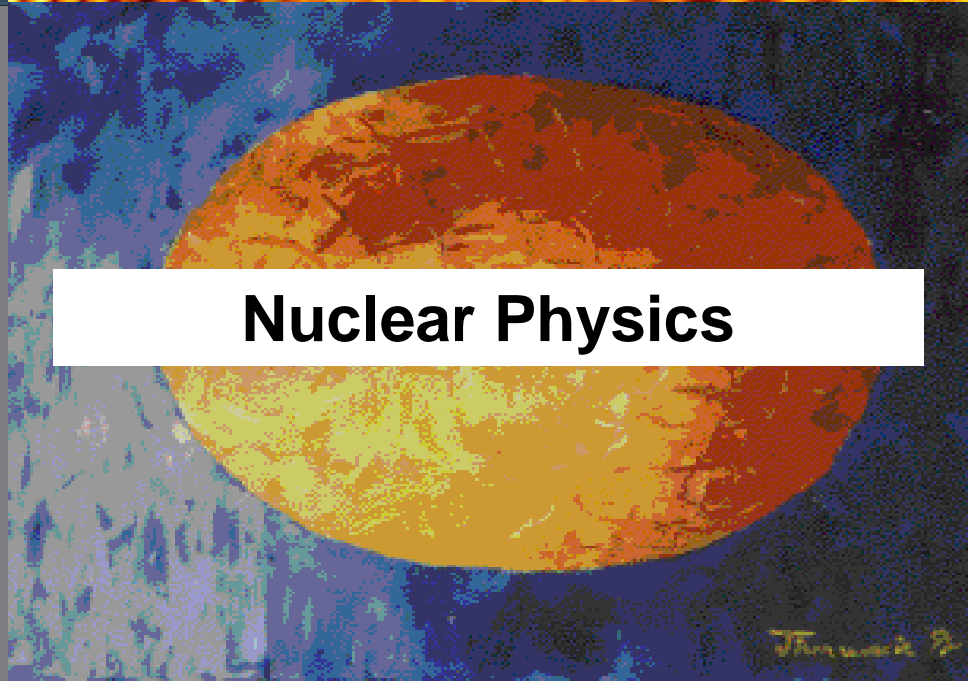

Nuclear Physics

Department of Physics

- **600 students**
- **25 faculty members**
- **3 Collaborative Research Centres (SFB)**
- **Research grants: 8.5 M€/a**



**Bonn-Cologne Graduate School of Physics and Astronomy
(German Excellence Initiative 2007)**

Institute of Nuclear Physics – Institut für Kernphysik

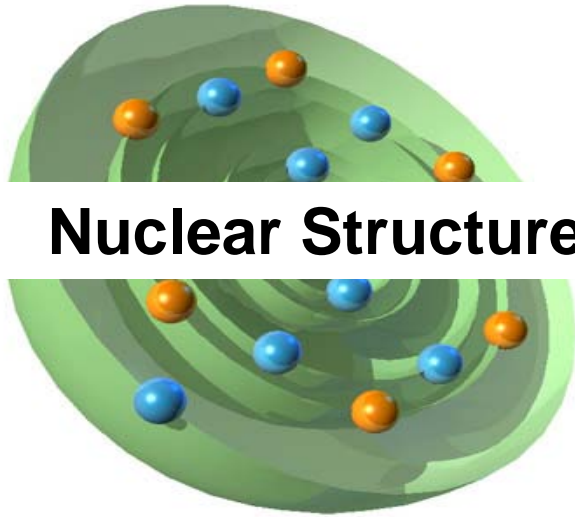

Nuclear Structure



Nuclear Astrophysics

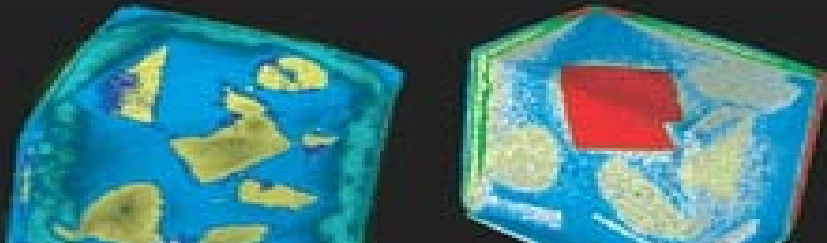

Applied Nuclear Physics

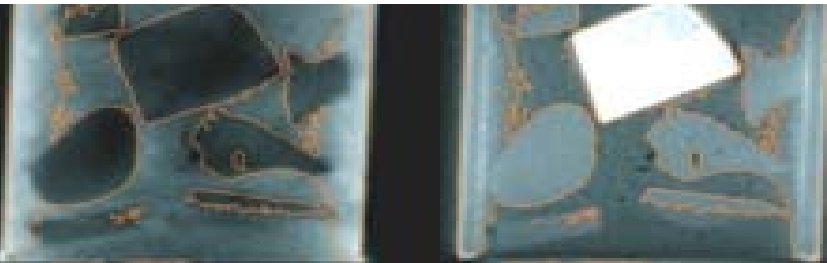

Detector development

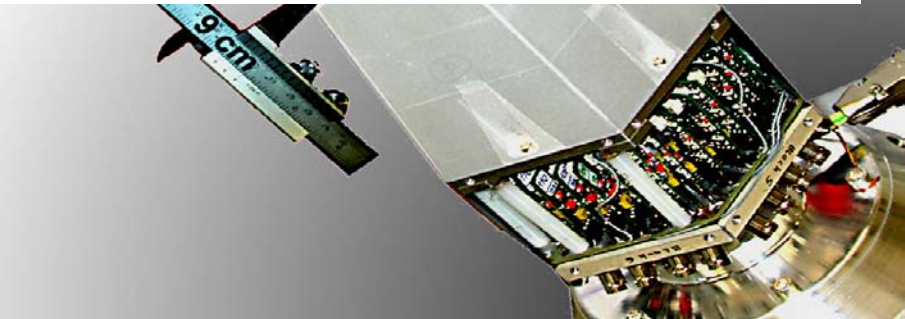

Institute of Nuclear Physics – Institut für Kernphysik

- Alfred Dewald
- Jan Jolie
- Peter Reiter
- Andreas Zilges

- Hans Ströher (FZ Jülich)

- Peter von Brentano (emer.)

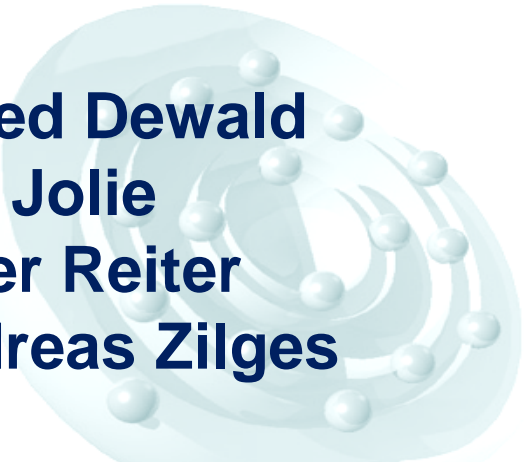

9 Postdocs
21 PhD students
16 Master/Diploma students

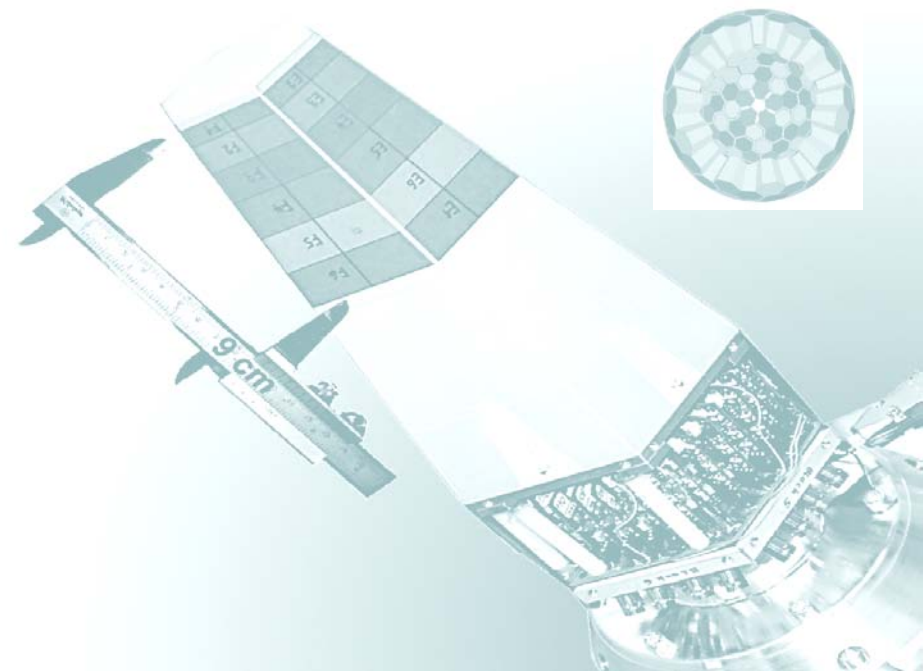

Mechanical Workshop - Institute of Nuclear Physics

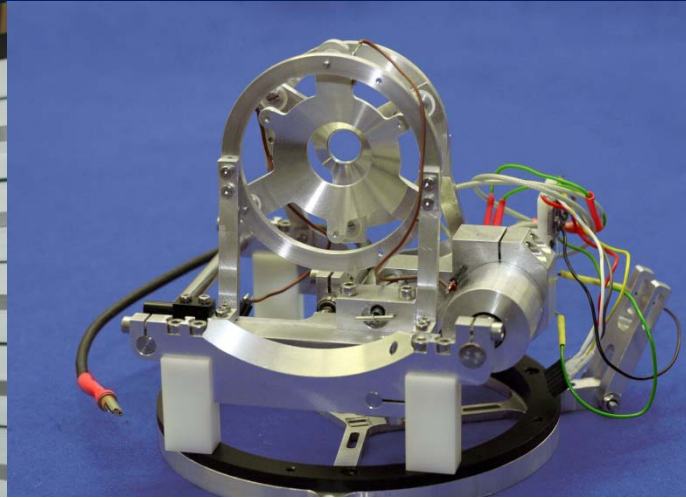
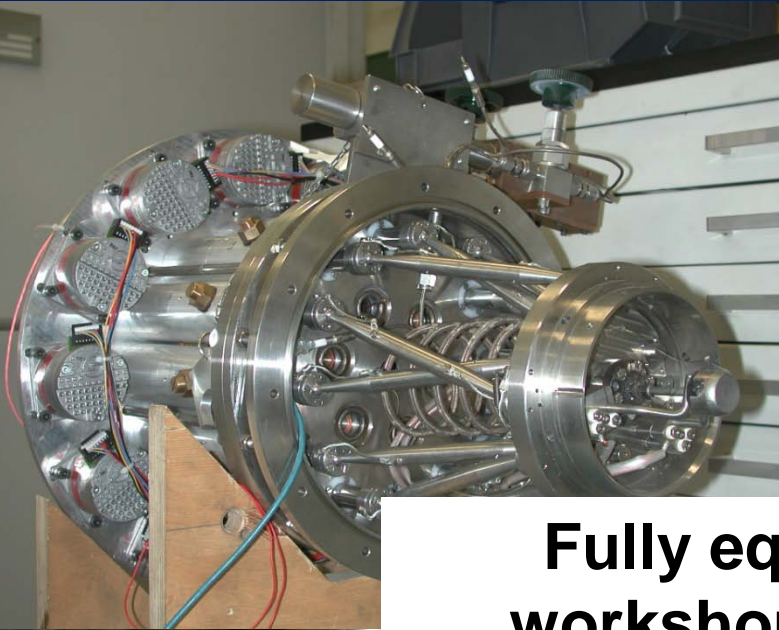

Fully equipped mechanical workshop with 15 employees

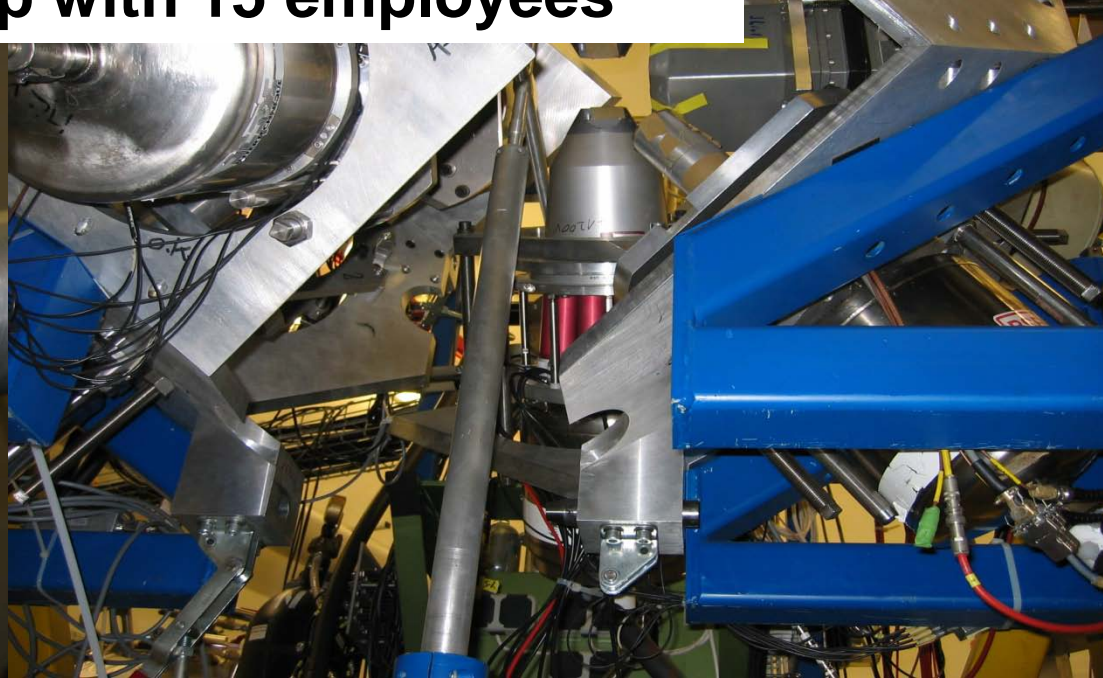
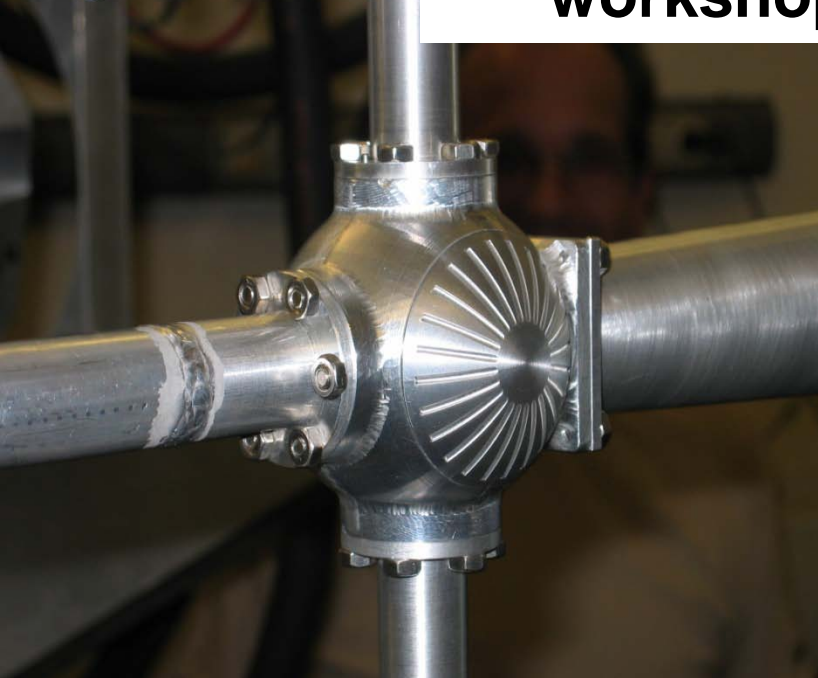

Electronics workshop - Institute of Nuclear Physics

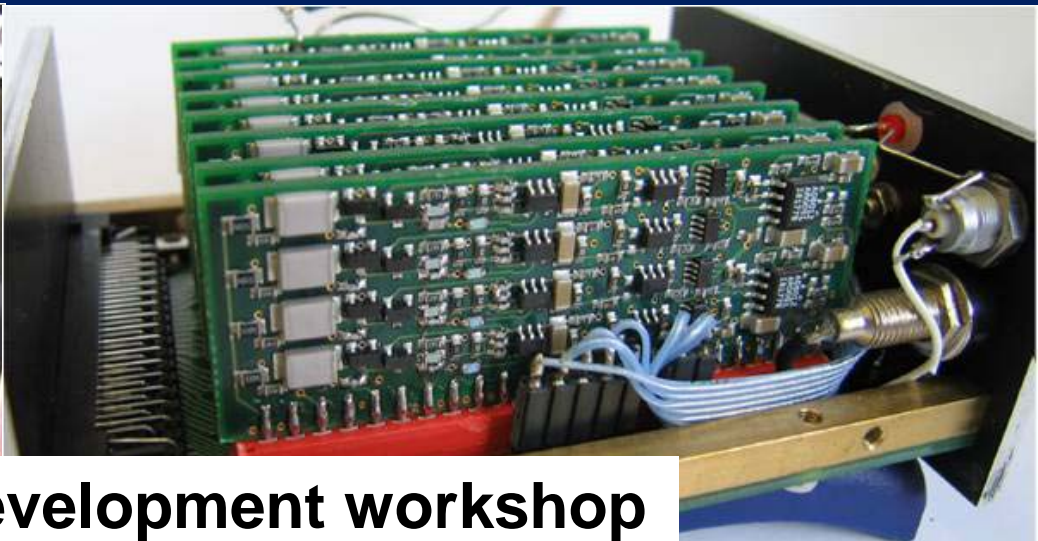

Electronics development workshop with 8 employees

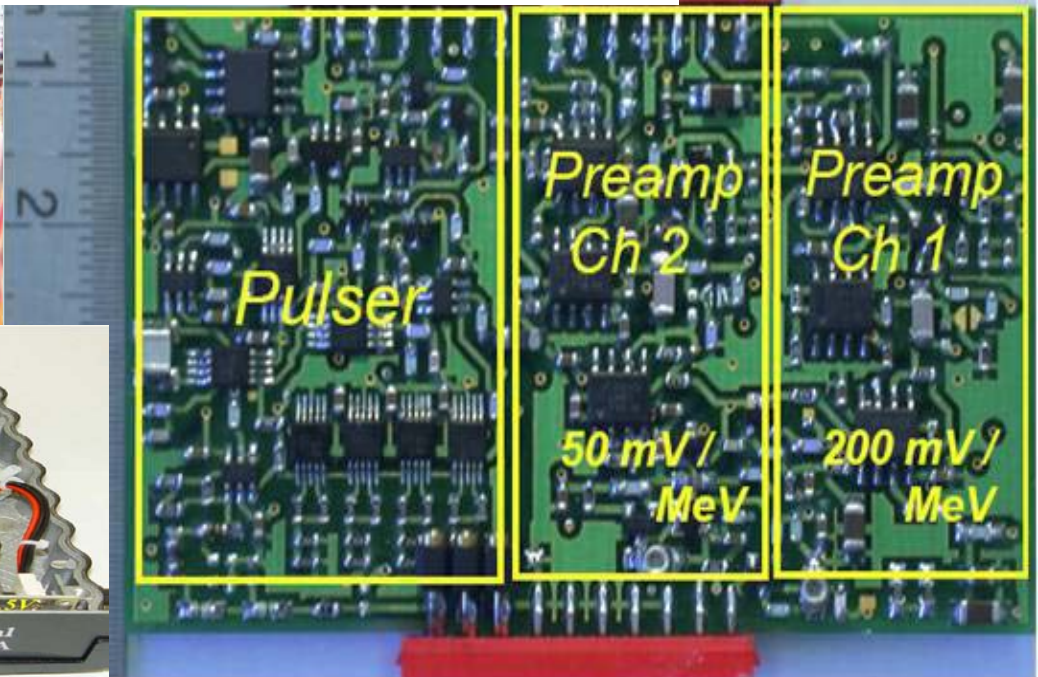

FN Tandem Accelerator at IKP

- Up to 10 MV terminal voltage
- Pelletron charge system (since 2004)
- Beam can be pulsed
- Two ion sources:
 - duoplasmatron (p, ^3He , ^4He)
 - sputter source (up to $A=127$)



Accelerator Mass Spectrometry at IKP (under construction)

Geosciences, Prehistory, Protohistory, Nuclear Physics

- 6 MV terminal voltage
- standard isotopes: ^{10}Be , ^{14}C , ^{26}Al , ^{36}Cl , ^{129}I
- ample beam time for development



CologneAMS (Start: 2010)

A. Dewald, J. Jolie, and A. Zilges, Nuclear Physics News 18 (2008) 26

DFG



Universität
zu Köln

GFZ
Helmholtz-Zentrum
POTSDAM

Nuclear Structure

- The nucleus is a mesoscopic quantum system
- Ab initio descriptions are in many cases not feasible
- Symmetry properties reduce the degrees of freedom considerably

Important observables of excited states:

- Energies
- Spins
- Parities
- Decay patterns
- Lifetimes

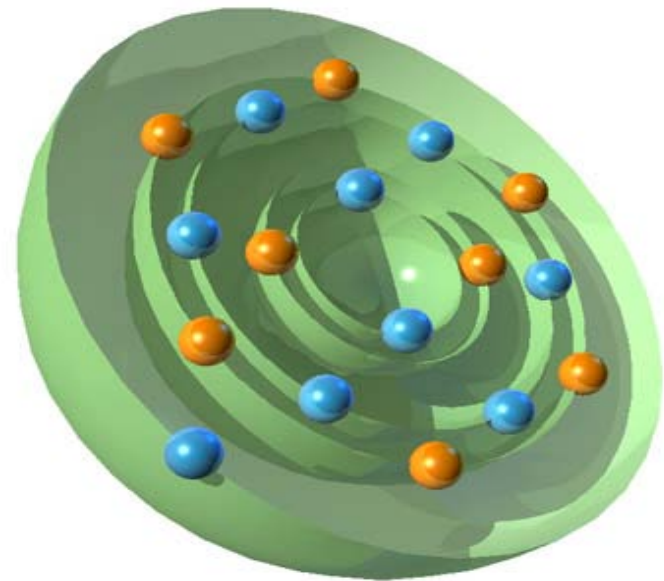

Lifetimes: Recoil Distance Doppler Shift Method

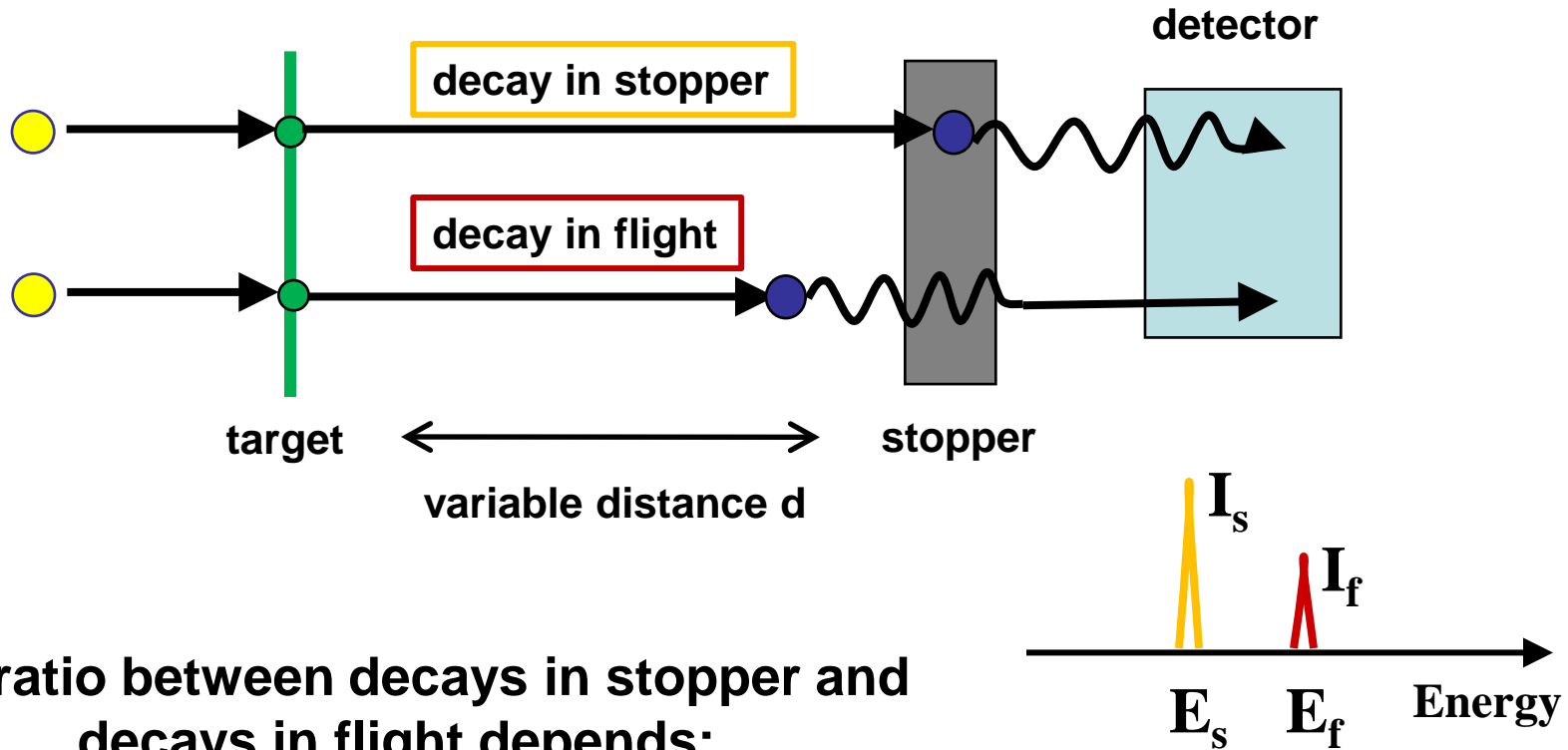

The ratio between decays in stopper and decays in flight depends:
on the distance d ,
the lifetime of the excited state τ ,
and the recoil velocity v .

Lifetimes: The Cologne Plunger

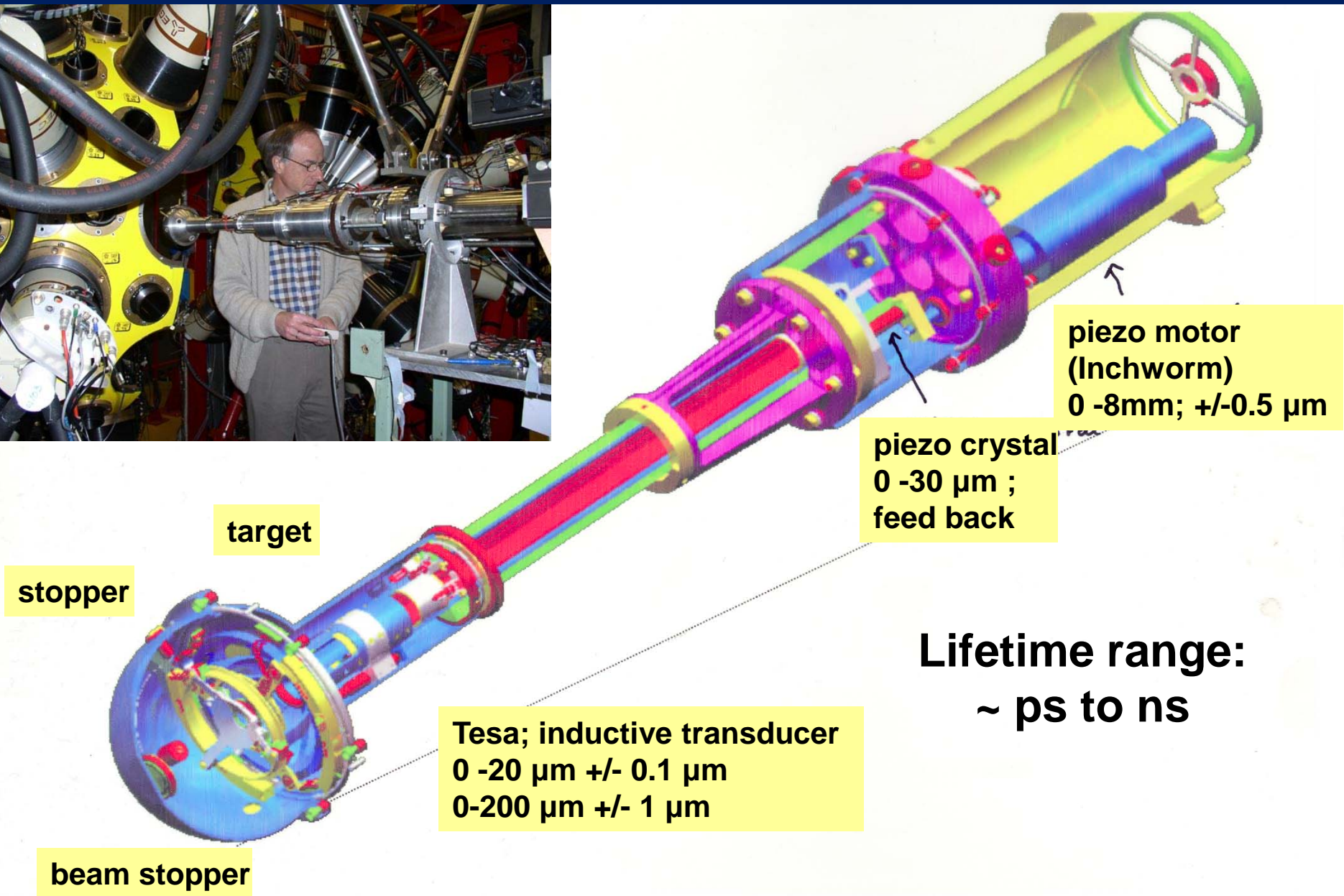

Lifetimes: The Cologne Plunger

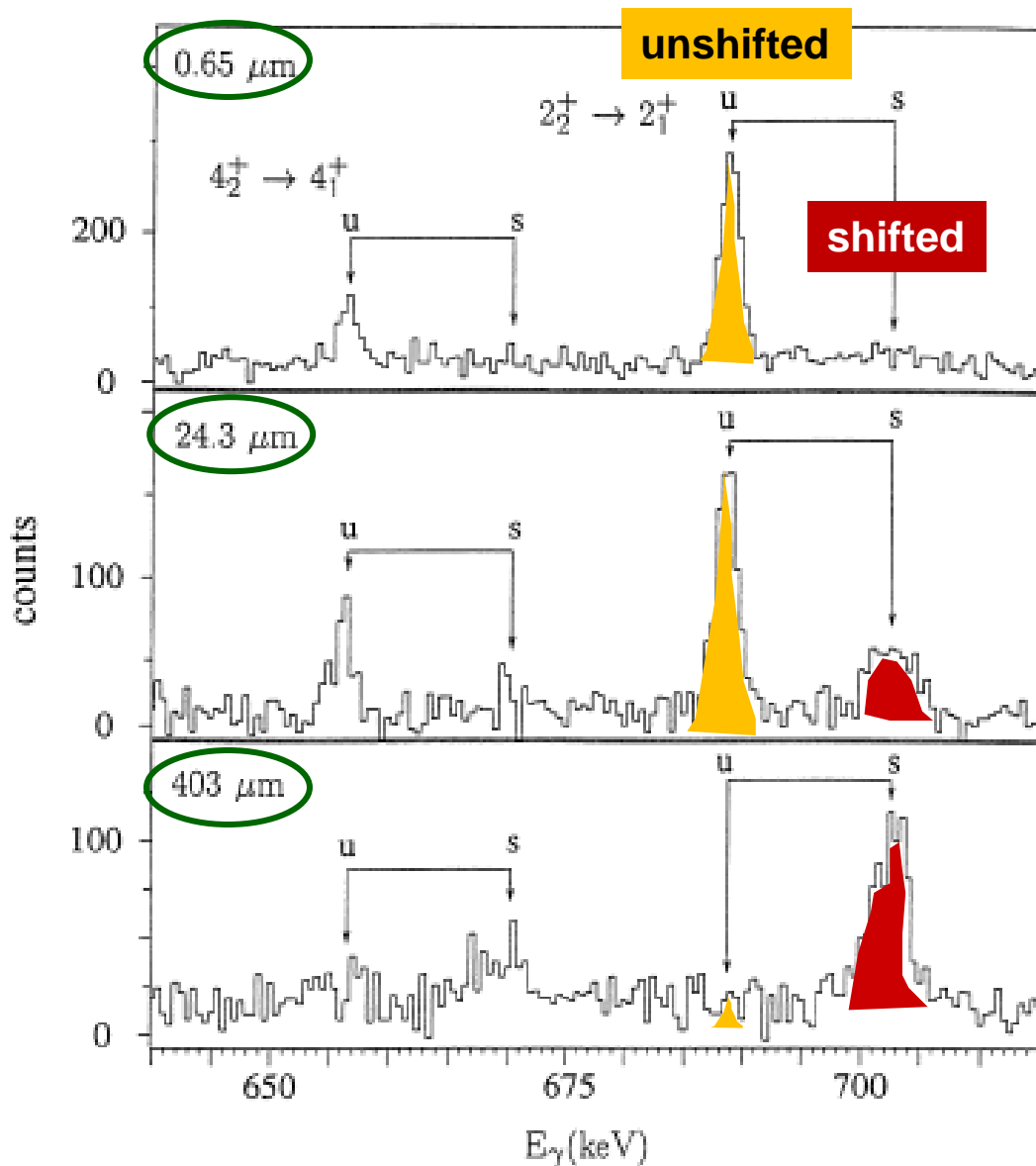
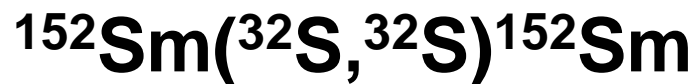

T. Klug, A. Dewald et al.

Cologne Plunger worldwide

- 
- **INFN Legnaro, Italy**
 - **Jyväskylä, Finland**
 - **NSCL/MSU, USA**
 - **Argonne National Laboratory, USA**
 - **GANIL, Caen, France**
 - **Yale University, USA**
 - **IFIN-HH Bukarest, Romania (under construction)**
 - **Demokritos, Greece (planned)**

Lifetimes: The Cologne Plunger

PRL 102, 242502 (2009)

PHYSICAL REVIEW LETTERS

week ending
19 JUNE 2009

**Lifetime Measurements of the Neutron-Rich $N = 30$ Isotones ^{50}Ca and ^{51}Sc :
Orbital Dependence of Effective Charges in the fp Shell**

PHYSICAL REVIEW C 80, 044331 (2009)

First measurement of lifetimes in the π band of ^{100}Pd

PHYSICAL REVIEW C 80, 014324 (2009)

Evolution of collectivity in ^{180}Hg and ^{182}Hg

PRL 102, 202502 (2009)

PHYSICAL REVIEW LETTERS

week ending
22 MAY 2009

Low-Lying Neutron Intruder State in ^{13}B and the Fading of the $N = 8$ Shell Closure

Eur. Phys. J. A 39, 291–294 (2009)

DOI 10.1140/epja/i2008-10724-1

THE EUROPEAN
PHYSICAL JOURNAL A

Regular Article – Experimental Physics

Lifetime measurement in ^{195}Po

Nuclear Astrophysics

What is the origin of energy and radiation in our universe?

How were and are the chemical elements synthesized?

Ingredients:

- **Astrophysics**
- **Nuclear Physics**



Synthesis of Nuclei

What is the production mechanism of heavy nuclei on the proton rich side of the valley of stability ?

→ *p*-process

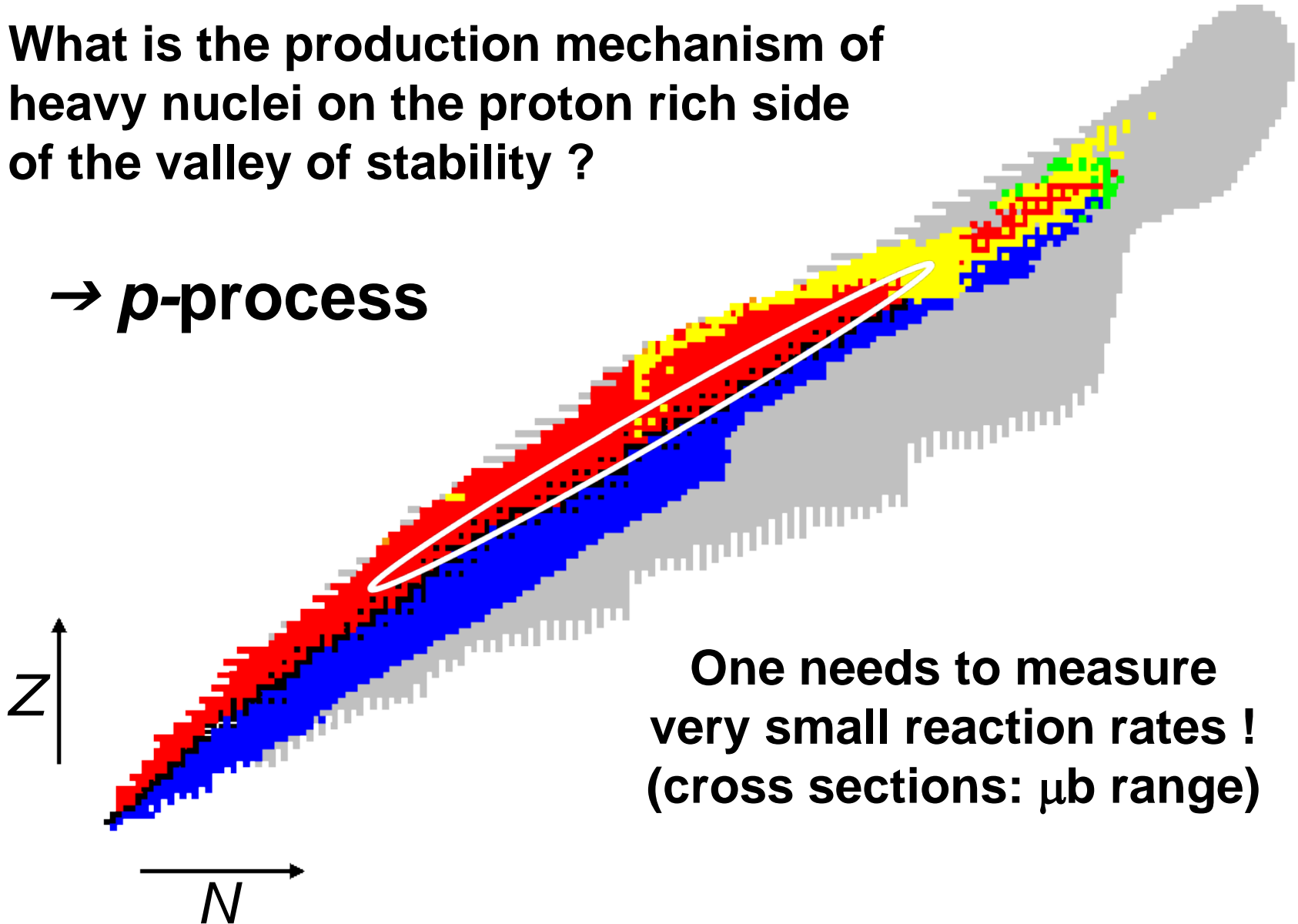

One needs to measure very small reaction rates !
(cross sections: μb range)

In beam experiments using a NaI crystal

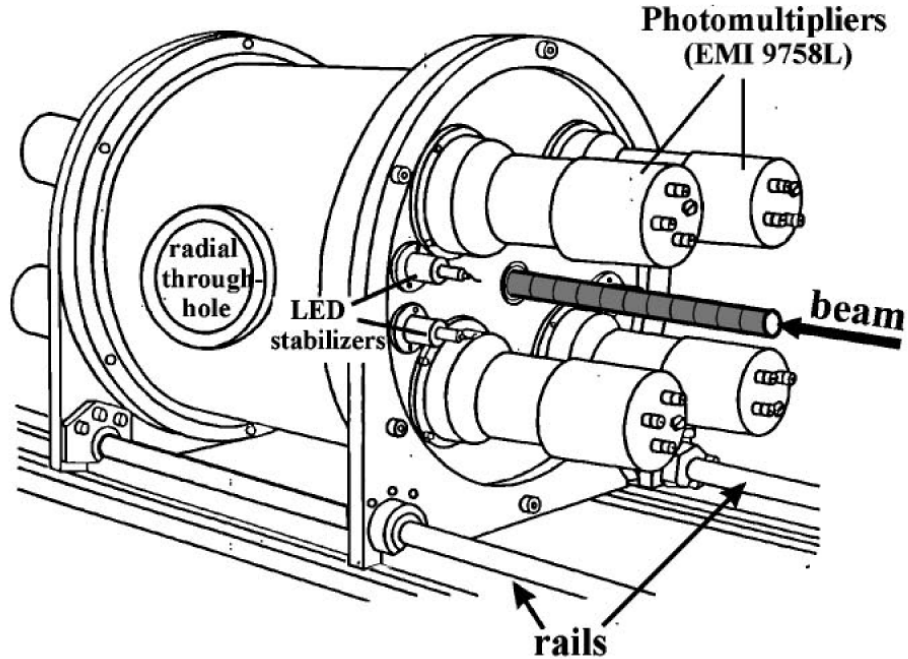

- + Very high efficiency
- + „simple“ data evaluation
- No detailed information

e.g.: P. Tsagari et al., *PRC* 70 (2004) 015802

In beam experiments using HPGe detectors

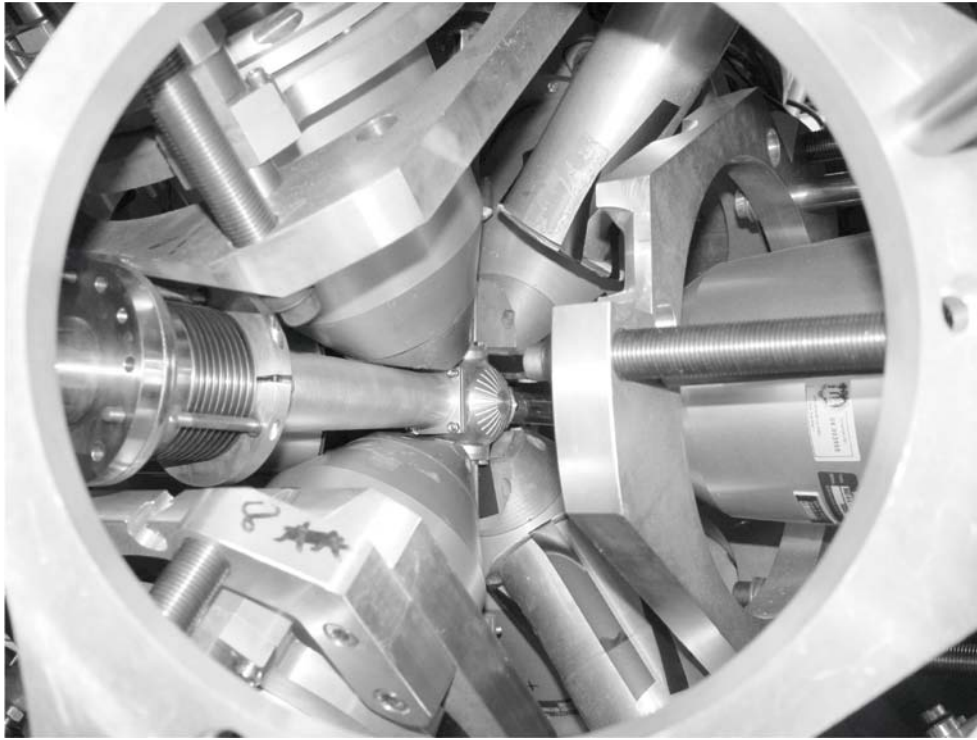

HORUS @ IKP Köln:

- 14 HPGe detectors in close geometry
- Photopeak efficiency at 1332 keV: up to 5%

- High energy resolution to observe single transitions
- Adequate efficiency to study low cross sections
- Determination of angular distributions possible
- Coincidence technique to suppress background

Radiative proton capture on ^{92}Mo

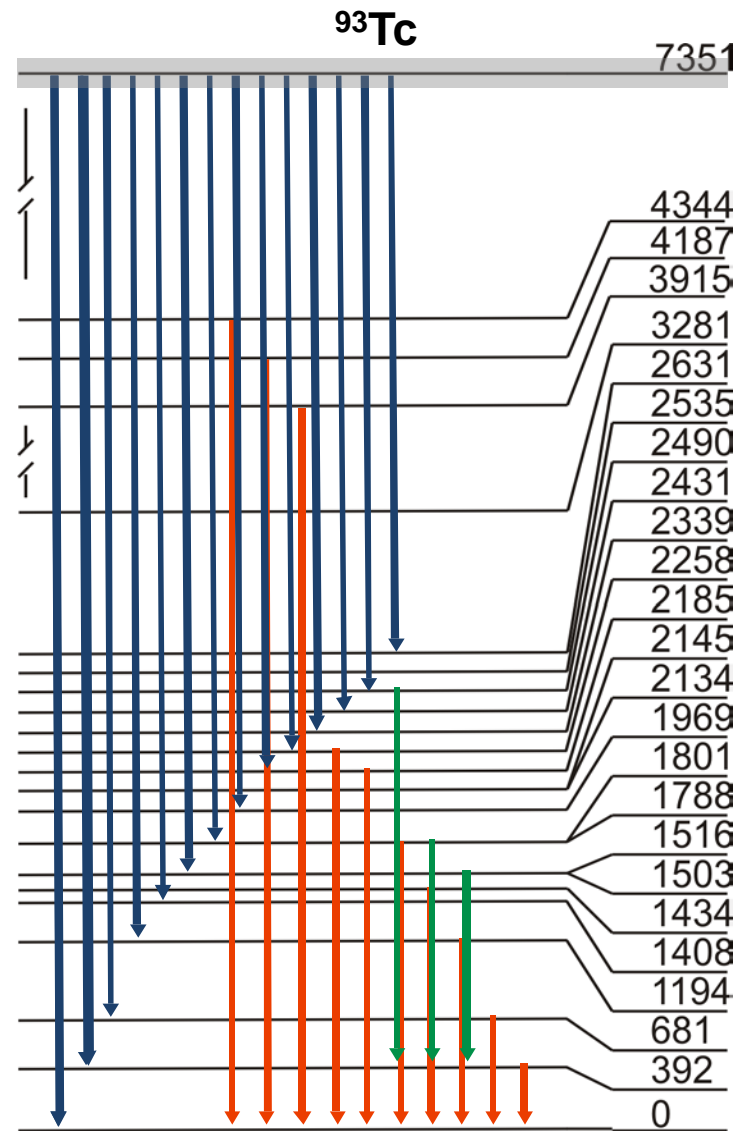
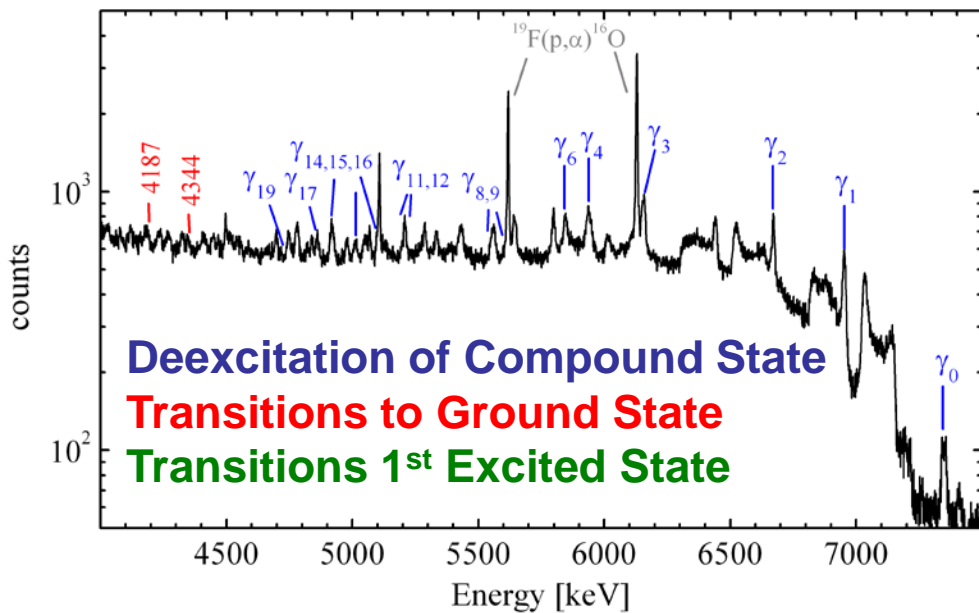
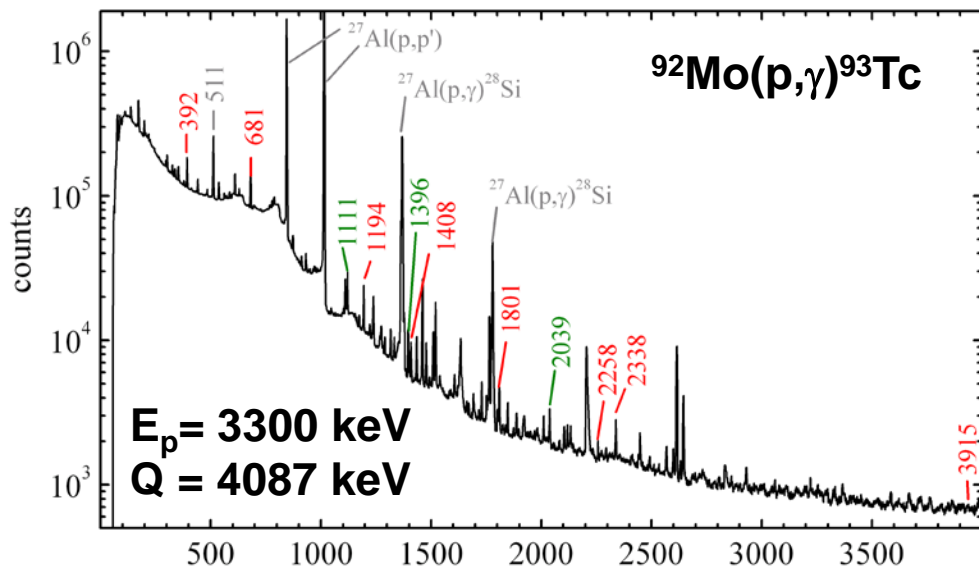

Production of 1st excited state

Background suppression with coincidence techniques

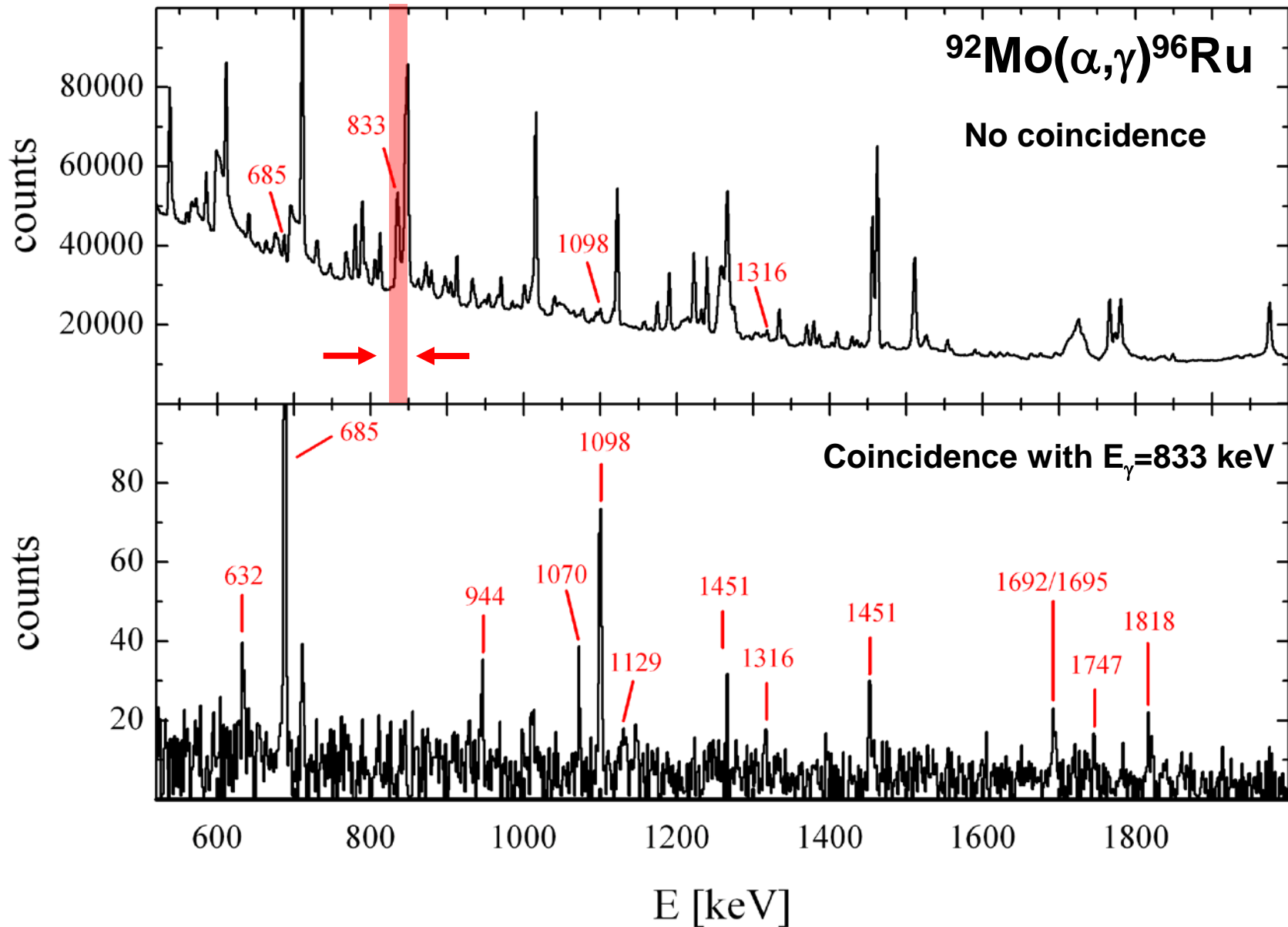

Collaboration LIBRA – IKP Köln

Study of the Pygmy Dipole Resonance in $(\alpha, \alpha'\gamma)$ and (γ, γ') experiments

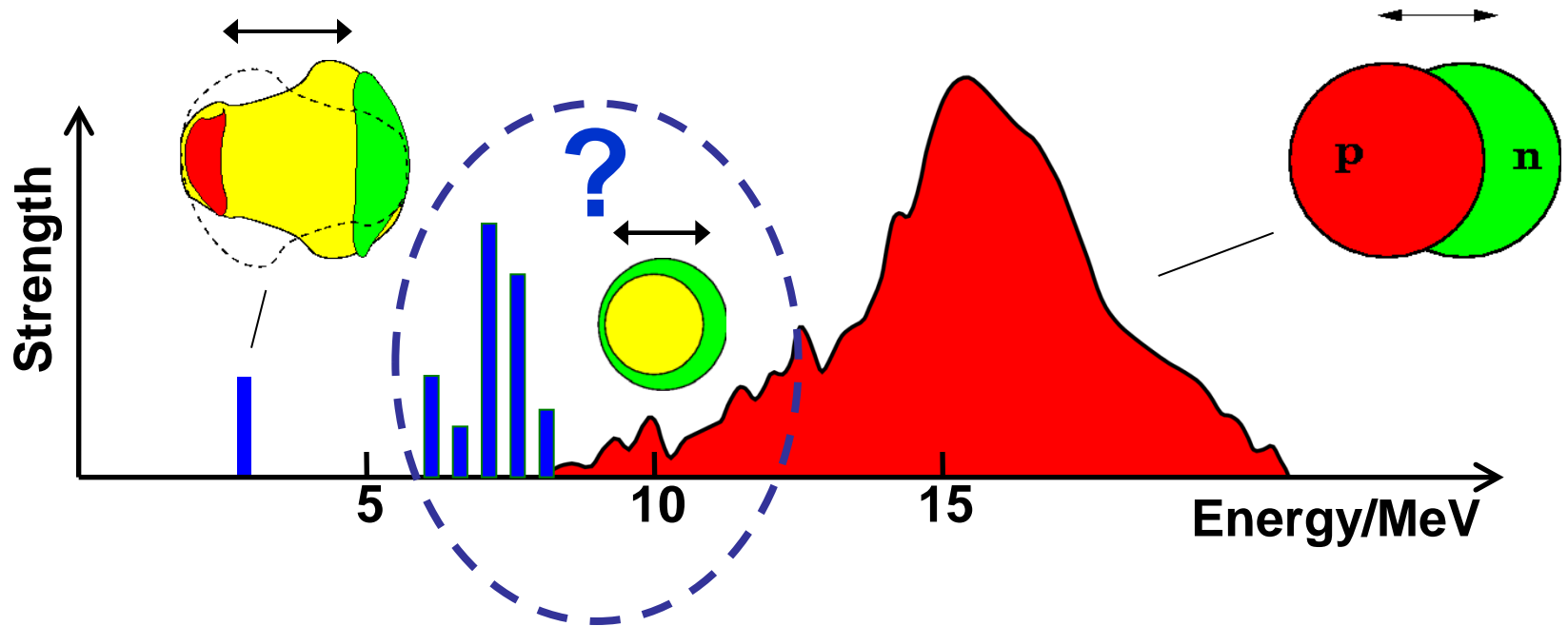

TECHNISCHE
UNIVERSITÄT
DARMSTADT



Collaboration LIBRA – IKP Köln

Study of the Pygmy Dipole Resonance in $(\alpha, \alpha'\gamma)$ and (γ, γ') experiments

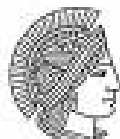
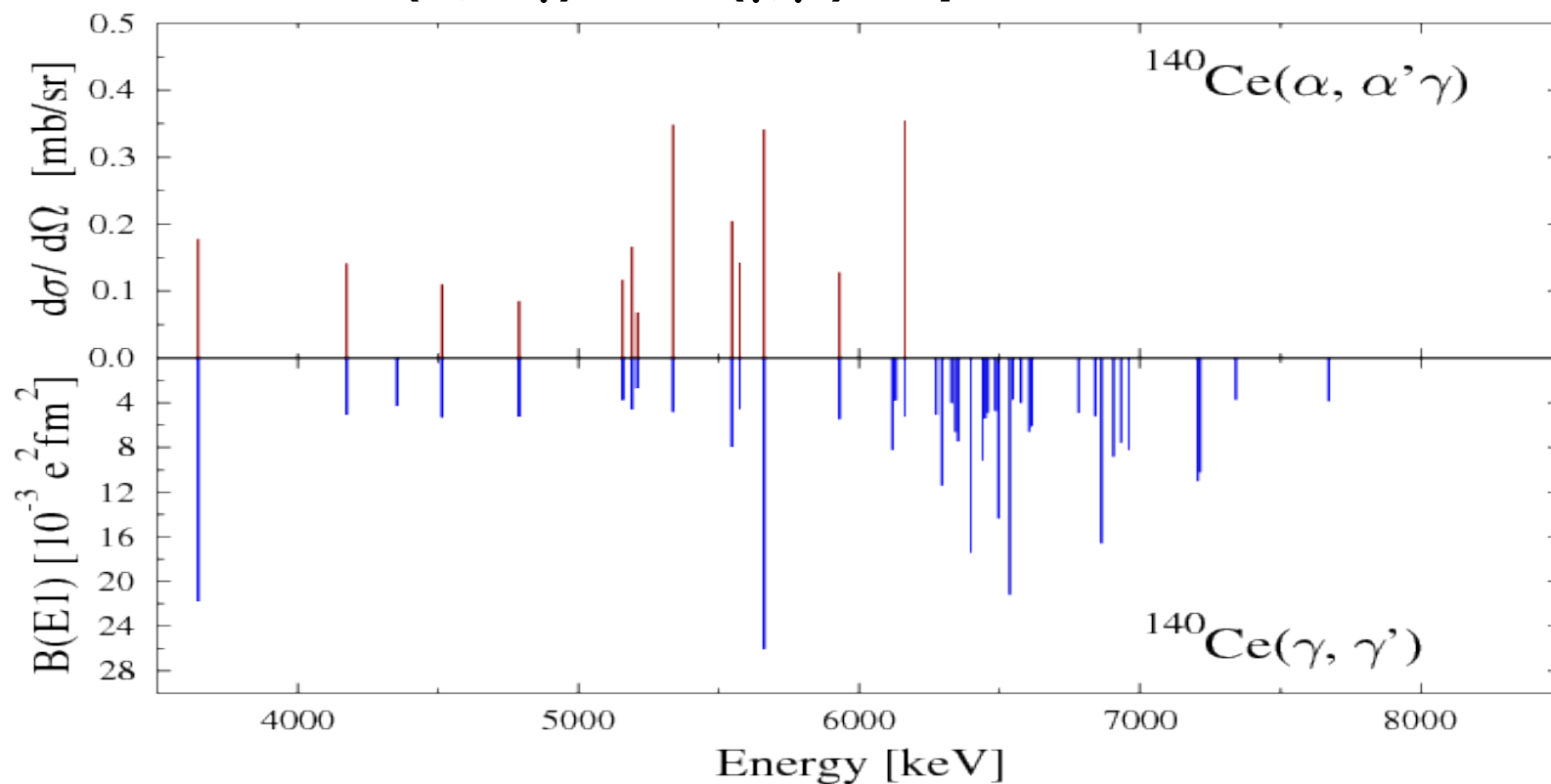

TECHNISCHE
UNIVERSITÄT
DARMSTADT



„Stuttgart“ HPGe detector pool

- 3 x 100% HPGe detectors
- 1 x 80% HPGe detector
- BGO shields
- Electronic modules

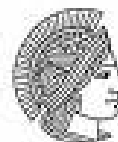
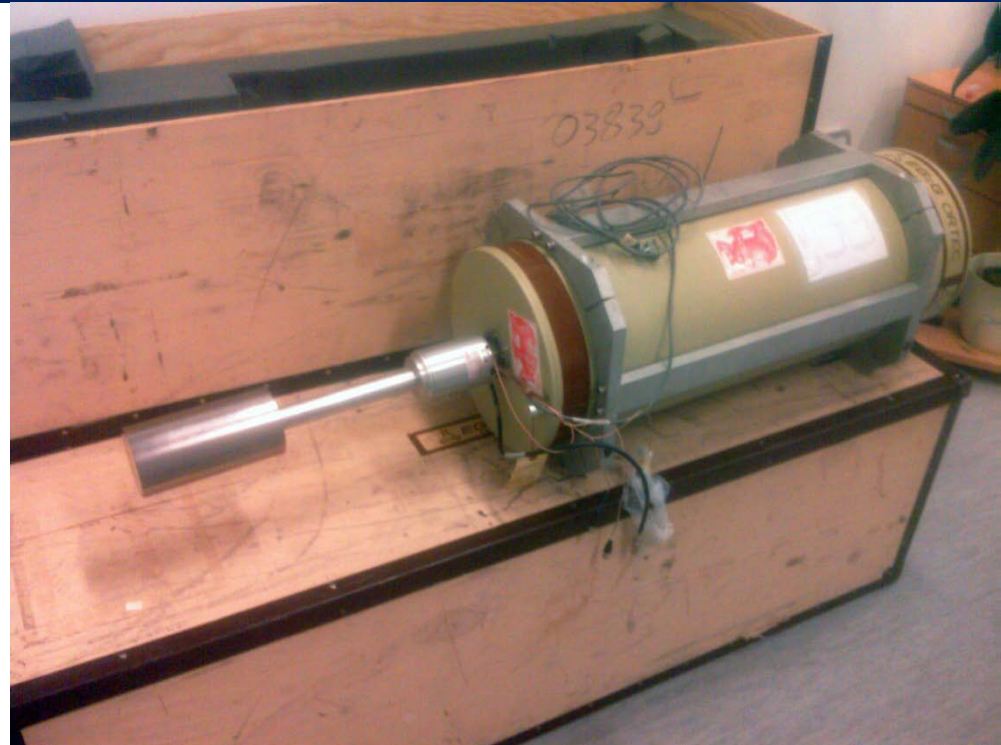

TECHNISCHE
UNIVERSITÄT
DARMSTADT



LIBRA Partner Institution Universität zu Köln: Symmetries, Lifetimes and the Synthesis of Nuclei

